

LOW AIR LOSS MATTRESS SYSTEMS

SelectAir®
SelectAir Max™
BariSelect™

LOW AIR LOSS MATTRESS OVERLAY SYSTEMS

HybridSelect™

Operations Manual



SUPPLIER: This manual must be given to the user of this product.

USER: Before using this product, read this entire manual and save for future use.

Table of Contents

ENGLISH

Section 1	Introduction	2-3
Section 2	System Components	4-5
Section 3	Safety Precautions	6
Section 4	Important Safeguards	7-8
Section 5	Installation	9-11
Section 6	Manual Setup	12-13
Section 7	Maintenance	14-15
Section 8	Cleaning and Disinfecting	16-18
Section 9	Troubleshooting	19-20
Section 10	<i>SelectAir</i>	21-22
Section 11	<i>SelectAir Max</i>	23-26
Section 12	<i>BariSelect</i>	27-31
Section 13	<i>HybridSelect</i>	32-34
Section 14	<i>SelectAir</i> Product Information	35-36
Section 15	Warranty	37

Manufactured by: **MOXI Enterprises, LLC.**

1939 South Vandeventer Avenue, Saint Louis, Missouri 63110

www.moxiusa.com

Toll Free: 1.800.942.7678 • Local: 314.771.5222 • Fax: 314.771.5225

© MOXI Enterprises, LLC. 2010

The following are trademarks and registered trademarks of The ROHO Group, Inc.: ROHO®, shape fitting technology®, HIGH PROFILE®, ELIMSTAPH®, Hi-Tor®, Velcro® and Sentinal® are registered trademarks of their respective companies.

MOXI Enterprises, LLC. has a policy of continual product improvement and reserves the right to amend specifications presented in this brochure.

Introduction

SelectAir[®] low air loss mattress systems are pressure relief mattress systems designed for the treatment and/or prevention of pressure ulcers and other tissue trauma, including burns and other wounds. *SelectAir* systems are designed to work with any standard hospital mattress and will fit on a variety of different bed frames.

Indications for Use

- Pressure Ulcers
- Rehabilitation
- Oncology
- Multiple Sclerosis
- Cardiovascular
- AIDS
- Burns
- Spinal Cord Injury
- Orthopedics
- Neurosurgery
- Plastic Surgery
- Extended Care
- Geriatrics
- Arthritis
- Skin Flaps/Grafts
- Pain Management
- Dermatology
- ALS



ATTENTION: ELECTRICAL EQUIPMENT





















1. Class I equipment
2. Type BF equipment
3. Ordinary equipment
4. Continuous Operation
5. Environmental Conditions:
 - Operating Limits:

Temperature:	50° - 90°F (10°C to 32°C)
Humidity:	80% RH Maximum
Altitude:	6,560 Ft. (2,000 Meters)
 - Storage Limits:

Temperature:	32° -122°F (0°C to 50°C)
Humidity:	80% RH Max.

Symbol Legend

	Attention- See accompanying instructions for use or information found in this manual or labels on the control unit.
	Electrical Hazard
	Fire or Explosion Hazard
	Replaceable fuse
	On/Off Button
	Off Only Button
	Function Button
	CPR / Emergency Off Button
	Auto Comfort Button
	Firm Button
	Comfort Level Settings (Softer, Firmer)
	Lock, Unlock Button
	Pulsate Mode
	Low Setting Button for Pulsation Mode
	Medium Setting Button for Pulsation Mode (Not available on the HybridSelect model)
	High Setting Button for Pulsation Mode
	Upright Button
	Type BF Equipment

The above symbols are used on product labeling and in this manual as defined by International Electrotechnical Commission or MOXI Enterprises, LLC.

System Components For Mattress Replacement Models

Figure 1

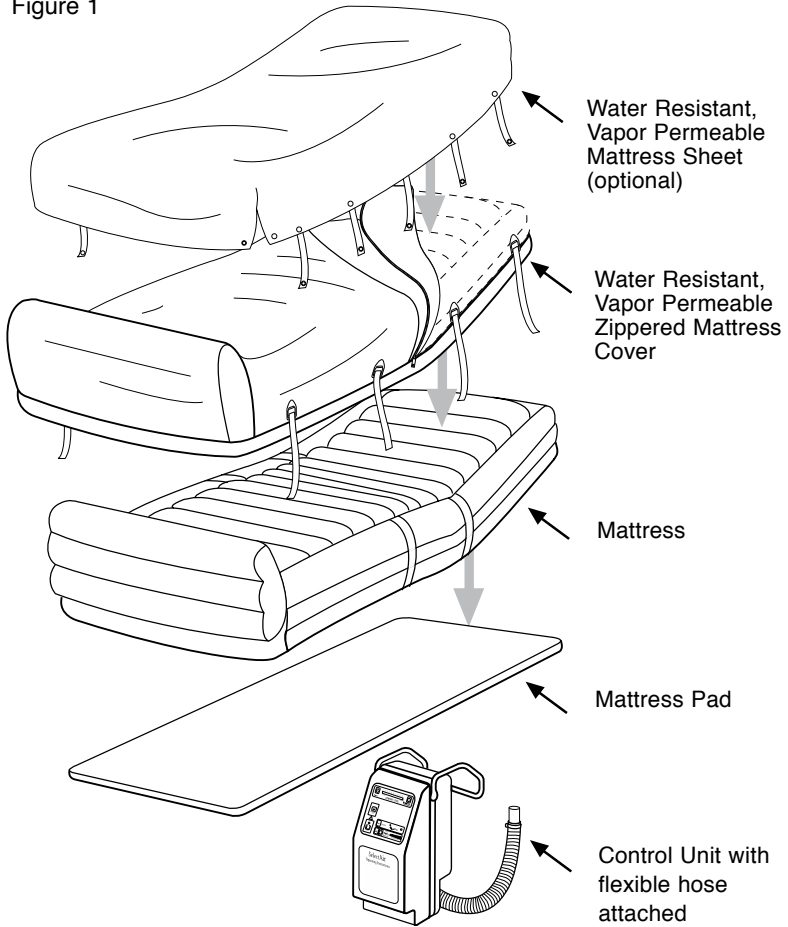

Note: *SelectAir* and *SelectAir Max* mattress replacements are available in different heights, lengths and widths. *BariSelect* is available in various widths.

System Components For HybridSelect Mattress Overlay Models

Figure 2

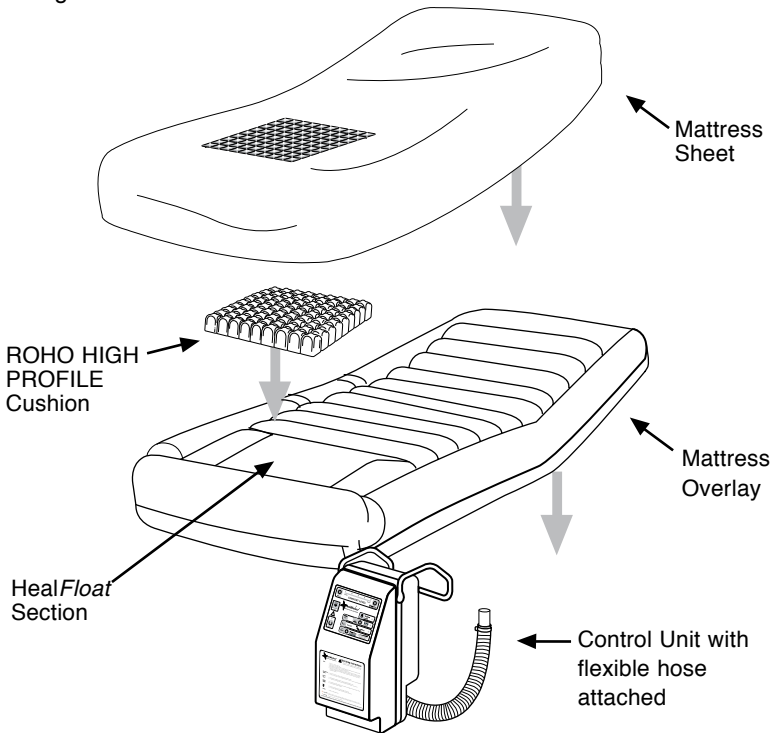

Safety Precautions

Please read and thoroughly understand the following safety precautions before using this product.

**WARNINGS**

- Explosion risk if used in the presence of flammable substances.



- Risk of fire, replace fuse as marked on control unit:



- Possible fire hazard when used with oxygen administering equipment other than nasal mask or 1/2 bed length tent type. Oxygen tent shall not extend below the mattress support level or enclose the control unit.



- Electrical shock hazard. Do not remove back cover.



- Do not use in the presence of smoking materials or open flame. Air flowing through air mattress will support combustion.

PRECAUTIONS

- Grounding reliability can only be achieved when the power cord supplied with the control unit is connected to an equivalent grounded receptacle.
- Unplug the control unit from the wall outlet before cleaning (see Section 8).
- Refer all servicing to qualified service personnel.
- For mattress overlays, use a side rail extender if the top of the bed rails are less than six (6) inches (15 cm) from the top of the mattress overlay.
- The use of bed frame side rails in conjunction with any *SelectAir* low air loss mattress system should be determined based upon facility protocol, applicable laws and regulations, and individual user safety considerations. Bed frame side rail usage is not a requirement for the functional operation of any *SelectAir* product, but individual safety requirements and/or facility protocol may dictate that side rails be utilized.

Important Safeguards

Please read and follow the instructions regarding *SelectAir* mattress and overlay systems and retain this manual for future reference. Follow all warnings and instructions marked on the control unit and mattress as well as those listed in this manual.

Note: DO NOT place liquids on top of the control unit.

Handling

Handle the control unit with care. Dropping it may cause internal damage and can cause the control unit to malfunction.

Note: DO NOT use a control unit if it appears to be damaged. Consult an authorized MOXI / *SelectAir* distributor.

Dust or Dirt

Keep the *SelectAir* control unit away from excessive dust or dirt, which can cause premature failure. The control unit is supplied with a replaceable air filter that should be replaced every 90 days under normal conditions. The air filter should be inspected and cleaned every month under normal conditions, and more frequently when used in abnormally dusty or dirty environments.

Cleaning

Unplug the control unit from the wall outlet before cleaning. Do not use harsh liquid chemicals, cleaning solvents or aerosol cleaners. Water and a mild dish washing detergent may be used on a soft, damp cloth or paper towel. Please refer to Section 8.

Accessories

Do not place the control unit on an unstable surface because it may fall, causing severe damage to the control unit. Use only manufacturer-recommended accessories. Any mounting of the control unit must follow the manufacturer's instructions. The hospital bed footboard must be able to support the control unit and any additional weight.

Heat and Ventilation

Refer to page 2 of this manual for operating and storage limits. It is important that this opening is not blocked or covered during operation. The control unit should not be placed in a built-in installation, such as a closet or rack unless proper ventilation is provided.

Power Sources

The control unit should only be operated from an appropriate AC outlet capable of safely delivering at least three (3) amps of electrical current. If you are not sure of the type of power supply available, consult your MOXI / *SelectAir* distributor or a certified electrician.

Object Entry and Excess Weight

Never push objects of any kind into this product. Excess weight placed on the control unit can cause damage to the housing.

Grounded Power Cord and Plug

This control unit is equipped with a grounded power cord. The plug will fit into the power outlet only one way. If you are unable to insert the plug fully into the outlet, contact your

MOXI / *SelectAir* distributor prior to operating the control unit. Do not alter the plug to fit into the power outlet. The power supply cord should be routed so it will not be walked on or pinched by items placed upon it or against it.

Overloading

Overloading wall outlets can result in a risk of fire or electric shock. A single grounded extension cord (three wires with grounded plugs) of less than 25 feet (7.6 meters) in length and with a minimum of a 15 amp rating can be used with the control unit.

Servicing

Do not attempt to service this control unit yourself. Opening or removing the cover may expose you to hazardous voltages. Refer all servicing to your MOXI / *SelectAir* distributor. Breaking or removing calibration seals voids the warranty of the control unit.

Mattress Storage

Clean and disinfect product as per this operation manual and store in a dry environment at room temperature.

Replacement Parts

When replacement parts are required, be sure that the control unit uses replacement parts from the manufacturer. Unauthorized substitutions will void the warranty.

Safety Check

Upon completion of any service to this product, the MOXI / *SelectAir* distributor must perform safety checks to determine that the product is in a safe operating condition.

Interference

The control unit is designed to prevent radiation of radio-frequency energy. There is no guarantee that communications or other radio-frequency interference will not occur in a particular installation. If this control unit does cause harmful interference to radio or television reception, which can be determined by turning the control unit off and on, the user is encouraged to try to correct the interference by one or more of the following steps:

- Make sure electrical cord is properly grounded.
- Relocate the receiving antenna of the device affected.
- Increase the separation between the control unit and the device affected.
- Connect the control unit to an outlet that is on a different circuit than the device being affected.

Installation - Mattress Replacements

Mattress

Note: Make sure that the mattress hose fitting is at the foot end of the bed frame.

A. When using the Mattress Cover with Mattress Replacement:

While the mattress is inflating, it may be helpful to partially unzip the cover and guide the mattress into the correct formation.

1. *Always* remove the existing mattress from the bed.
2. Before placing mattress inside mattress cover, ensure that all four side bolster straps (two per side) are securing side bolsters to mattress sections and Velcro® fasteners are mated.
3. Insert the mattress and mattress pad inside the mattress cover and zip the cover shut. Place on the bed frame. Be sure the hole in the mattress cover is in the correct position to fit around the hose fitting outlet on the mattress.
4. Strap the cover to the bed frame using the four straps located on each side of the mattress cover.

B. When using the Mattress Cover and the Mattress Sheet with Mattress Replacement:

1. *Always* remove the existing mattress from the bed.
2. Before placing mattress inside mattress cover, ensure that all four side bolster straps (two per side) are securing side bolsters to mattress sections and Velcro® fasteners are mated.
3. Insert the mattress and mattress pad inside the mattress cover and zip the cover shut. Place on the bed frame. Be sure the hole in the mattress cover is in the correct position to fit around the hose fitting outlet on the mattress.
4. Strap the cover to the bed frame using the four straps located on each side of the mattress cover.
5. Fit the mattress sheet over the covered mattress and attach the straps to the bed frame.

Installation - Overlay Models

Mattress Overlay

Note: Make sure that the mattress hose fitting is at the foot end of the bed frame.

A. Mattress Overlay Instructions

1. Place the mattress overlay on top of the existing mattress.
2. Insert hose into the foot section of the mattress overlay.
3. Insert the ROHO HIGH PROFILE cushion into the cushion cover. (HybridSelect™ only.)

- Place the ROHO HIGH PROFILE cushion into the HealFloat foot section of the mattress overlay.

Note: Refer to the cushion's enclosed operating instructions for proper setup and adjustment.

- After inflating the mattress overlay, secure the mattress sheet to the mattress.
- Remove the ROHO HIGH PROFILE cushion and place on chair to provide continued skin protection while patient is seated in a chair. Readjust the cushion for the patient according to the cushion's instructions.

Control Unit - All Models

- Place the control unit handle over the edge of the footboard. The handle will self adjust to the width of the footboard (fig. 3).
- Insert the hose fitting with the clip into the air outlet of the control unit and turn 1/4 turn. Ensure the hose fitting is firmly seated and that the latch 'clicks' into place (fig. 4).
- Insert the other end of the hose into the mattress hose fitting located at the foot of the mattress (fig. 4).

Figure 3

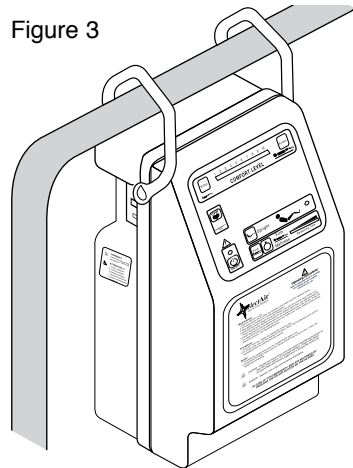

Figure 4

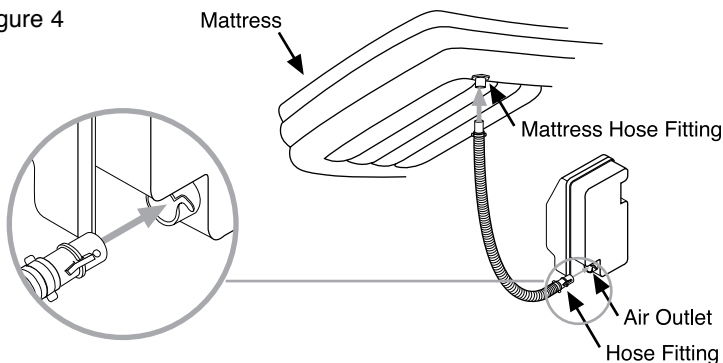

Figure 6

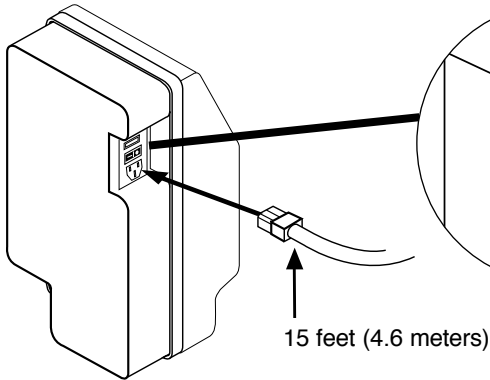
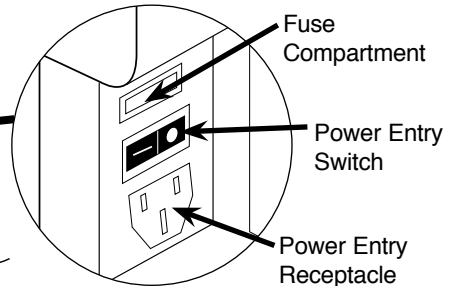
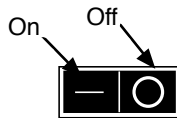

Figure 7



4. Ensure the power entry switch is "OFF".

Figure 5



5. Firmly insert the power cord into the outlet on the control unit (fig. 6).
6. Insert the other end of the power cord into an equivalent grounded power receptacle.
7. Press the power entry switch "ON" and refer to Manual Setup (Section 6).

Note: Check to make sure all hose connections are secure before turning on.

Section 7

Manual Setup

Manual Setup

1. Press the "On/Off" button on the keypad to the "On" position and allow the mattress to FULLY inflate before making any adjustments or placing the patient on the mattress.

Figure 8



2. Press the firm mattress timer.

Figure 9A

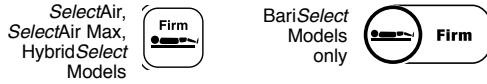

3. Place the patient on the mattress, centered and in their habitual resting position, i.e. on their back, on their side, etc.

CAUTION: The bed rails should be locked in their highest position before proceeding.

4. Press the Firm Mattress “OFF” button if illuminated.

Figure 9B



5. Determine the patient’s weight and set the Comfort Level using the Comfort Level “Softer” and “Firmer” buttons to the matching information on the Comfort Level Chart (pg.13). See section 12 for instructions on how to manually input the patient’s weight on the BariSelect model.

Figure 10

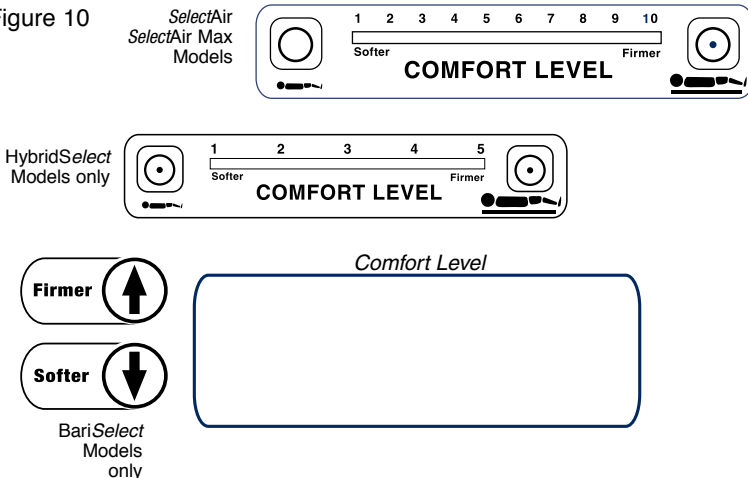

Note: Due to the different shapes and sizes of each patient, the settings recommended on the Comfort Level Chart are only a guideline. User judgement must be applied to properly adjust the Comfort Level to the setting that best suits the patient.

6. Allow air in the mattress to equalize for a minimum of two (2) minutes before proceeding.

7. Check to ensure that the patient has immersed into the mattress about 40 – 50%. If they have not, adjust the Comfort Level using the Comfort Level “Softer” and “Firmer” buttons and repeat steps 6 and 7 until the proper results are achieved.
8. Once the desired setting is found, check to see if there is adequate clearance between the patient and the bed frame by placing your hand between the patient and the bed frame. There should be 3-4 inches (7-10 cm) of clearance, and the patient should not be touching the bed frame at any point. Adjust the Comfort Level setting until the proper results are achieved.

Comfort Level Reference Chart

Note: These charts are only a guideline because weight distribution varies from patient to patient.

		Patient Weight		Setting
		(Pounds)	(Kilograms)	(Comfort Level)
SelectAir SelectAir Max Weight Ranges	}	75	34	3.5-4
		100	45	4
		125	57	4-5
		150	68	5
		175	79	5-6
		200	91	6-7
		250	113	7-8
		300	146	8-9
		350	159	9
		400	181	10

		Patient Weight		Setting
		(Pounds)	(Kilograms)	(Comfort Level)
BariSelect Weight Ranges	}	300	146	6
		350	159	7
		400	181	8
		450	204	9
		500	227	10
		550	249	11
		600	272	12
		650	295	13
		680	308	13.5

		Patient Weight		Setting
		(Pounds)	(Kilograms)	(Comfort Level)
HybridSelect Weight Ranges	}	100	45	1
		150	68	2
		200	91	3
		250	113	4
		300	146	5

9. Follow facility protocol, applicable laws and regulations, and individual user safety considerations for usage of bed frame side rails.

Maintenance

Control Units

All control units are designed to be virtually maintenance free. The only servicing required is cleaning of the housing and changing the filter.

Note: The control unit contains no other user serviceable parts and it should only be opened by qualified service personnel.

Fuse



DANGER: THE FUSE MUST ONLY BE REPLACED WITH THE PROPER FUSE AS LISTED ON THE INFORMATION LABEL. DO NOT REPLACE THE FUSE WITH ONE OF HIGHER VALUE OR OF DIFFERENT TYPE.

To replace the fuse:

1. Turn off the main power switch on the power entry module, located on the left side of the unit.
2. Unplug the line cord from the wall socket, remove the other end from the power entry module, and set aside.
3. Insert a small flat screwdriver into the slot located at the top of the power entry module and carefully open the fuse holder door.

Note: Before opening, observe what voltage is visible on the red fuse holder through the window on the fuse holder door.

4. Carefully remove the red fuse holder to access the fuse.
5. Check fuse with a continuity tester.
6. Replace bad fuse with the correct version listed on the information label.
7. Replace the red fuse holder in the power entry module.
8. Close the fuse holder door ensuring the correct voltage appears when the door is closed.
9. Plug the line cord into the power entry module and plug the other end into an appropriate grounded outlet.
10. The unit is now ready to resume normal operation.

Filter

The filter should be inspected and cleaned every month under normal conditions. Inspect filter and clean or replace as necessary. Bariatric patients generally require higher air pressure for support, therefore, the air filter should be inspected and replaced more frequently.

To check and change the filter:

1. Firmly pull forward and then down on the filter tray located at the front of the control unit. The filter tray will automatically stop in the fully opened position (fig. 11). It is not necessary to completely remove the filter tray.

Important: Keep the filter clean and the air opening clear of obstacles.

2. Remove the filter from the filter tray (Fig. 12) by grabbing the filter by its edges and inspect the condition of the filter.

If dirty, wash the filter in a mild detergent. Let the filter dry completely before replacing the filter back into the filter tray. If the filter is torn or in bad condition, replace it with a new one.

Note: Do not use the control unit without a filter.

3. Replace the filter by firmly pressing the filter in around the edges in the filter tray.
4. Ensure the filter is laying flat and push the filter tray up into the housing.

Figure 11

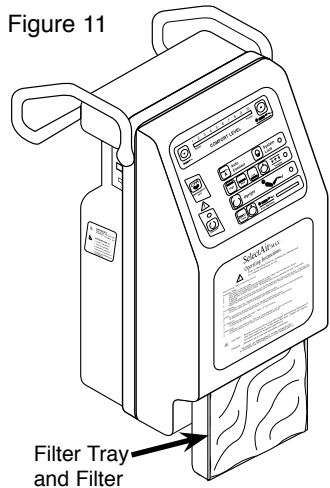
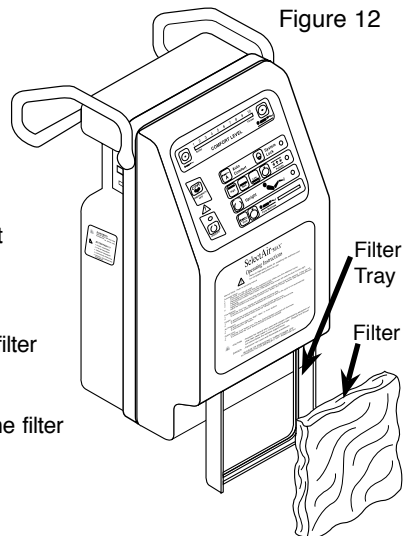

Figure 12



HealFloat Feature (HybridSelect only)

To properly maintain the ROHO HIGH PROFILE Cushion in the HealFloat feature, refer to the cushion's operation manual.

Cleaning and Disinfecting

Note: The following instructions are intended only as general guidelines. Follow your facility's standard protocol for cleaning and disinfecting medical equipment. If you have any questions contact your MOXI / *SelectAir* representative or The MOXI Enterprises Service Department.

Mattress/Overlay (during use)

Clean with a mild detergent and a damp cloth. Do not use harsh chemicals, alcohol, or solvents. Wipe dry. The air mattress should be inflated while cleaning.

Note: Do not heat or steam clean. To assure safety from infection, completely disinfect all bedding using the proper cleaning recommendations.

Mattress/Mattress Overlay (between patients)

The air mattress or mattress overlay must be thoroughly cleaned between patients. To prevent moisture from entering the mattress, keep the mattress inflated throughout the cleaning process.

1. With the mattress or overlay inflated, spray the entire mattress with bleach diluted 1:10 bleach to water.
2. Allow bleach to remain on mattress or overlay for a maximum of 10 minutes.
3. Rinse the mattress or overlay with fresh water.
4. Spray surface with a disinfectant. MOXI recommends using LpHse® diluted 1:256.
5. Allow solution to remain on mattress or overlay for a maximum of 10 minutes.
6. Brush soiled areas and rinse with fresh water.
7. Allow air flow to continue through the mattress or overlay for 10 minutes after completion of cleaning procedure to prevent any moisture from entering the mattress' or overlay's air holes.
8. Hang to dry.
9. Spray surface with a quaternary ammonium compound mixed as a 1% solution in water. MOXI recommends using Calgon Vestal Laboratories Coverage Spray Disinfectant Cleaner®.

Mattress Pad (between patients)

1. Spray pad with a disinfectant using high pressure spray. MOXI recommends using LpHse® diluted 1:256.
2. Allow solution to remain on pad for 10 minutes.
3. Brush all soiled areas and rinse with fresh water.
4. Hang to dry.

Mattress Sheet for Mattress or Mattress Overlay (between patients)

1. Presoak the sheet in a disinfectant for 10 minutes. MOXI recommends using LpHse® diluted 1:256.
2. Remove the sheet from the presoaked disinfectant and place in a standard agitator type washing machine. Take care not to overload the washing machine.
3. Thoroughly remove the disinfectant from the sheet by using two full regular wash/rinse cycles of the washing machine without any laundry detergent added. The

washing machine should be set at a regular wash, hot water setting.

4. Launder the sheet in a normal manner using the regular cycle and hot water wash setting of the washing machine. Use a standard laundry detergent as the laundering agent. Make sure that a full clear rinse cycle follows the wash cycle to remove all the cleaning solution residues.
5. Dry the sheet in a standard clothes dryer set at low heat (Delicate Fabrics) setting for 7-10 minutes.
6. After drying, the sheet may be repackaged and returned to clean inventory.

Zippered Mattress Cover (during use)

1. Wipe surface with neutral soap and lukewarm water.
2. Rinse with water and dry.

Zippered Mattress Cover (between patients)

Note: Do not clean with a phenolic-based cleaning solution as it will damage the urethane coating on the cover's nylon fabric. These instructions must be followed to maintain the quality and integrity of the material.

1. Deflate and remove the mattress from the mattress cover.
2. Place the mattress cover in a standard agitator-type washing machine. Take care not to overload the washing machine. You may presoak the cover in a quaternary solution (disinfectant) diluted with water. We recommend using Sentinal, Elimstaph or Hi-Tor solutions diluted 1:256.

Note: Wash in warm water [not warmer than 140°F (60°C)]. Do not use bleach.

3. After presoaking cycle is over, the washing machine should be set on delicate fabrics or permanent press cycle.

Note: Wash in warm water [not warmer than 140°F (60°C)]. Do not use bleach.

4. To remove any remaining disinfectant, wash mattress cover on delicate fabrics or permanent press cycle. Use a standard laundry detergent with NO bleach. Wash one cycle using the laundry detergent.

Note: Use cold water only. Do not use bleach.

5. Dry the cover in a standard clothes dryer set on delicate cycle with a low heat setting. TUMBLE DRY ONLY.

Note: Do not use high heat!

6. After drying, the mattress cover may be repackaged and returned to clean inventory.

HealFloat feature (HybridSelect only)

Refer to the ROHO HIGH PROFILE cushion's operating manual for specific cleaning instructions.

Control Unit and Hose (between patients)

1. Unplug the control unit from the wall outlet before proceeding.
2. Wipe down entire control unit and all hoses with a disinfectant solution. MOXI recommends using LpHse® diluted 1:256.
3. Allow solution to remain on system for 10 minutes.
4. Wipe down entire control unit and dry with disposable cleaning cloth or sponge.
5. Only use a mild detergent (dishwashing) and warm water to clean the filter. Rinse the filter with cool water and thoroughly air dry the filter before replacing.

All Control Units

DANGER: Disconnect control unit from main power supply before cleaning. Failure to do so could result in electric shock.

Note:

- Do not immerse the control unit in liquids.
- Do not heat or steam autoclave the control unit.

Note: Do not saturate the surface of the control unit with liquids. Wipe off any dust. If necessary, clean the housing exterior with a disinfectant solution or mild detergent and a damp cloth. Wipe dry.



DANGER: Make sure the control unit is completely dry before attempting to reconnect or operate it.

Troubleshooting

Problem/Corrective Action**1. Control unit does not function, and power light not illuminated.**

- Ensure the power cord is connected to a functioning power outlet supplying voltage indicated on the control unit label.
- Ensure that power cord is fully inserted into the power inlet receptacle on the side of the Control unit.
- Ensure the power switch on the power entry receptacle is switched to the “On” position (switched marked “-/0”, depress “-” to turn on).
- If above conditions are verified, check the control unit power fuse in the power inlet receptacle. See the “Maintenance” section of this manual for instructions on checking/changing the fuse.
- If, after replacement, the fuse blows again when power is applied, remove the unit from service and contact your MOXI / Select Air Distributor for assistance.

2. Control Unit does not function. Power and all comfort level light flash alternately, unit sounds single repeating beep.

- CPR Shutdown activated. Turn power switch on side of unit off for 10 seconds and back on to resume normal operation.

3. Control Unit does not function. Power and comfort level lights 1 and 10 flash alternately, unit sounds single repeating beep.

- Hose-loss alarm triggered.
- Ensure hose connections at control unit and mattress are secured, turn power switch on side of unit off for 10 seconds and back on to resume normal operation.
- If alarm triggers again after above steps, check mattress for large air leaks.

4. Control Unit does not function. Power light flashes and unit sounds double repeating beep.

- Power loss alarm triggered.
- Ensure the power cord is connected to a functioning power outlet supplying voltage indicated on the control unit label.
- Ensure that power cord is fully inserted into the power inlet receptacle on the side of the control unit.
- Press power button on front panel to resume normal operation.

5. Control Unit appears to function normally, but mattress does not inflate.

- Check hose for crushed or kinked areas, or internal blockages.
- Remove filter tray and ensure air inlet vent in control unit is free of obstruction. Ensure that mattress is not twisted or folded at hose connection.
- Check comfort level setting of control unit. Low setting may cause some sections of the mattress to inflate very slowly.

6. Control Unit appears to function normally, but is abnormally warm.

Some areas of the control unit case will become slightly warm during normal operation. If in question, compare temperature to another unit operating in the same conditions and at the same comfort level.

- Ensure that air inlet filter is not clogged or obstructed.
- Ensure that Control Unit air inlet is not blocked or obstructed by bedding or other materials.
- Ensure that there are no kinks or obstructions in hose to mattress.
- Ensure that ambient temperature is not above 90°F (32°C).
- Ensure that the control unit is not being used at an altitude exceeding 6560 feet (2000 meters)
- Ensure that the mattress is being used with the correct cover and/or sheet. Air must be allowed to escape from the air-loss holes in the top surface of the inner mattress for proper function.

7. Control Unit runs, but does not respond to keypad entries.

- Ensure operating environment temperature is not below 50°F (10°C). Allow control unit to warm to room temperature before use if stored in cold area.
- Internal software fault to prevent system damage or incorrect pressure.
- Turn power switch on side of unit off for 10 seconds and back on to resume normal operation.
- If problem persists, contact your MOXI / Select Air Distributor for assistance.

8. Patient comes in contact with bed frame after running Auto comfort mode.

- Auto comfort only provides approximate adjustment of comfort level. The caregiver must ensure correct flotation level of patient.
- Ensure patient has not changed their weight distribution on the mattress since setting comfort level, such as lying on side or drawing legs upward.
- See the "Manual Setup" section.

9. Refer to the "Safety Precautions" and "Important Safeguards" sections of this manual for additional guidance.

Figure 13

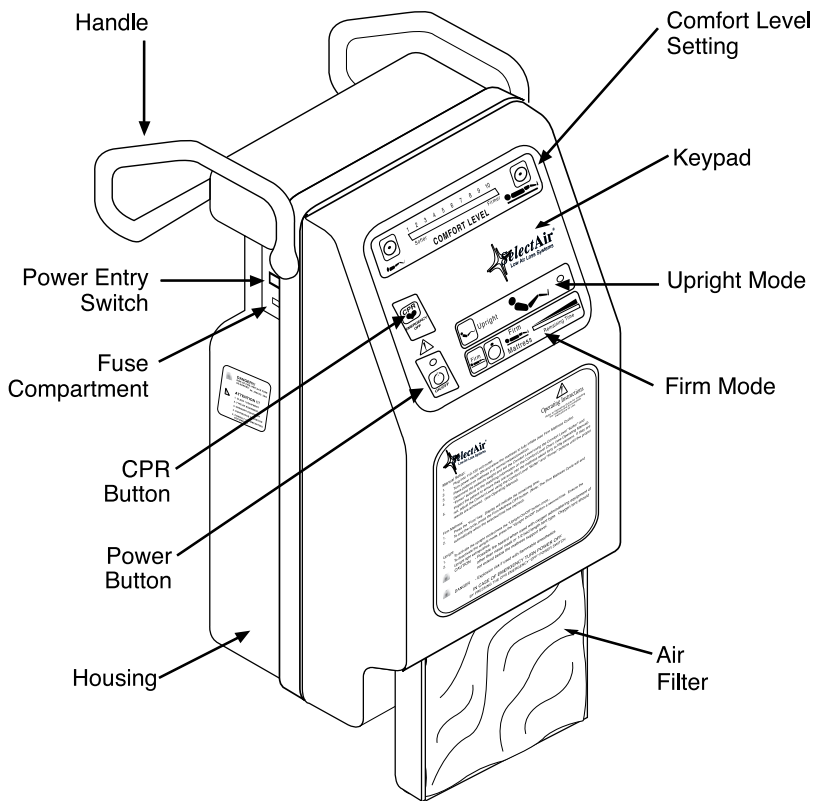

SelectAir

Upright Mode

The Upright Mode increases system pressure to compensate for the upright patient.

Note: When the patient is sitting up in bed, additional system pressure is required to keep the patient properly supported.

1. Before raising the patient to a sitting position, activate the Upright Mode by pressing the "Upright On/Off" button once (Ensure the Upright light illuminates), (fig. 14).

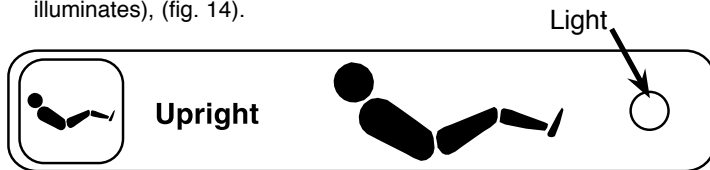

Figure 14

2. To deactivate the Upright Mode, first lower the patient to a lying position.

Then press the "Upright On/Off" button a second time (Ensure the upright light extinguishes).

Note: Do not leave the control unit in the Upright Mode when the patient is lying flat or at a slight angle.

Note: Ensure the patient has at least one (1) inch (3 cm) of clearance between the bed frame and their body. If not, manually increase or decrease system pressure to compensate.

Firm Mattress Mode

To aid in the placement and maneuvering of the patient, the control unit is equipped with a Firm Mattress Mode. The Firm Mattress Mode will fully inflate the mattress making it firm for easy positioning. The Firm Mattress Mode will automatically terminate when the time displayed on the keypad has expired.

1. Press the "Firm" button on the keypad. The display will indicate the remaining time (fig. 15).
2. To end the cycle press the Firm Mattress "Off" button.

Figure 15



Note: The *SelectAir* control unit is equipped with an internal timer which will turn the Firm Mattress Mode off after 20 minutes. If the Firm Mattress Mode has timed out and ended the firm mattress cycle, DO NOT press the Firm "Off" key as this may cause the system to "lock up".

Note: Pressing the Firm "Off" key multiple times or holding down the button may cause the system to "lock up".

Note: To ensure patient comfort, the control unit slowly lowers the pressure of the system. This may give the appearance that the firm function is still active. If the timer lights are extinguished, the control unit is in its normal mode.

CPR/Emergency Deflate

Important: In case of a CPR Emergency, turn power OFF by pressing the CPR button on the keypad.

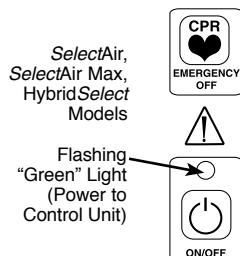
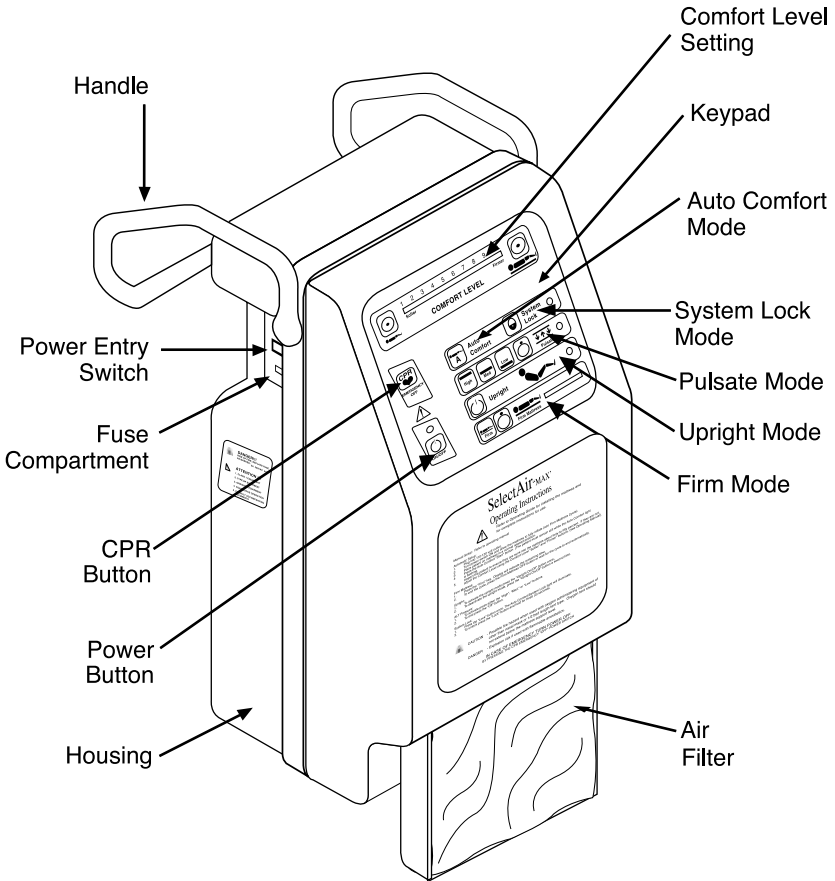

Figure 16

Note: To assist in deflating the mattress, disconnect the hose at the mattress or control unit.

Figure 17



SelectAir Max

Upright Mode

The Upright Mode increases system pressure to compensate for the upright patient.

Note: When the patient is sitting up in bed, additional system pressure is required to keep the patient properly supported.

1. Before raising the patient to a sitting position, activate the Upright Mode by pressing the "Upright On/Off" button once (Ensure the Upright light illuminates). (fig. 18).

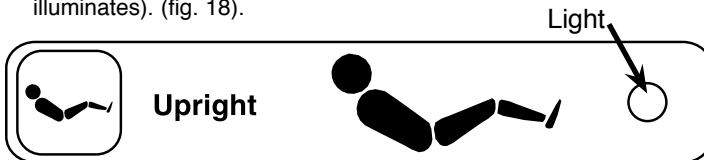

Figure 18

- To deactivate the Upright Mode, first lower the patient to a lying position. Then press the "Upright On/Off" button a second time (Ensure the upright light extinguishes).

Note: Do not leave the control unit in the Upright Mode when the patient is lying flat or at a slight angle.

Note: Ensure the patient has at least one (1) inch (3 cm) of clearance between the bed frame and their body. If not, manually increase or decrease system pressure to compensate.

Firm Mattress Mode

To aid in the placement and maneuvering of the patient, the control unit is equipped with a Firm Mattress Mode. The Firm Mattress Mode will fully inflate the mattress making it firm for easy positioning. The Firm Mattress Mode will automatically terminate when the time displayed on the keypad has expired.

- Press the "Firm" button on the keypad. The display will indicate the remaining time (fig. 19).
- To end the cycle press the Firm Mattress "Off" button.

Figure 19



Note: The *SelectAir Max* control unit is equipped with an internal timer which will turn the Firm Mattress Mode off after 25 minutes. If the Firm Mattress Mode has timed out and ended the firm mattress cycle, DO NOT press the Firm "Off" key as this may cause the system to "lock up".

Note: Pressing the Firm "Off" key multiple times or holding down the button may cause the system to "lock up".

Note: To ensure patient comfort, the control unit slowly lowers the pressure of the system. This may give the appearance that the firm function is still active. If the timer lights are extinguished, the control unit is in its normal mode.

System Lock

Control unit is equipped with the System Lock which suspends normal keypad operations (with exception of Firm Mattress, Upright and CPR on/off) until deactivated. When the Firm Mattress button is pressed while the System Lock is activated, the System Lock light will extinguish until the Firm Mattress Mode turns off.

- To lock the control panel, press the "System Lock" button (fig. 20). The System Lock light will come on.

Figure 20



- To unlock the control panel, press and hold the “System Lock” button for three (3) seconds. Ensure the System Lock light extinguishes.

Auto Comfort

This control unit is equipped with the Auto Comfort mode. When selected, the control unit will proceed through one or several (depending on the patient’s body type) cycles and will then calculate the approximate proper setting for the patient. If the setting selected by the control unit is not acceptable, then a second run of the Auto Comfort cycle may be necessary. If manual setup is desired see Manual Setup, Section 6.

- Turn the control unit on and allow the mattress to fully inflate before making any adjustments or placing the patient on the mattress.
- Place the patient on the mattress, centered and in their habitual resting position, i.e. on their back, on their side, etc.

Note: The bed rails should be locked in their highest position before proceeding.

- Deactivate the Firm Mode before starting Auto Comfort.
- Press the Auto Comfort “Start” button (fig. 21).

Note: The patient must remain still while the Auto Comfort light is flashing.

Figure 21



Note: Do not press any other keys until the Auto Comfort light is extinguished.

- Inspect the patient to ensure they have sunk into the mattress about 40-50 % and not touching the frame at any point. If they have not, adjust the Comfort Level using the Comfort Level “Softer” and “Firmer” buttons until the proper results are achieved.

Pulsate Mode

This control unit is equipped with the Pulsate Mode. When selected, the control unit will continuously readjust the system pressure (proportional to the Comfort Level setting). Change in pressure is gradual to ensure maximum patient comfort.

- To activate, press either the “High”, “Medium” or “Low” key (fig. 22) on the control panel. The Pulsate light will come on.

Figure 22

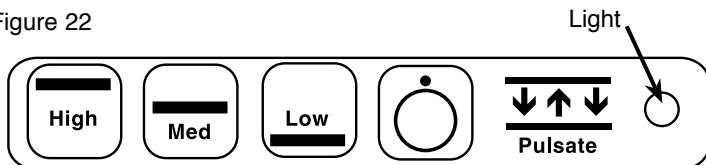

2. The Pulsate Mode adjusts as follows:
 - Low—20% cycle every 15 minutes
 - Medium—20% cycle every 7 minutes
 - High—20% cycle every minute.
3. To deactivate the Pulsate Mode, press the Pulsate off button (Fig. 23).

Figure 23



Note: You may change the rate of alternating pressure at any time while the Pulsate Mode is in operation.

CPR/Emergency Deflate

Important: In case of a CPR Emergency, turn power OFF by pressing the CPR button on the keypad.

Figure 24

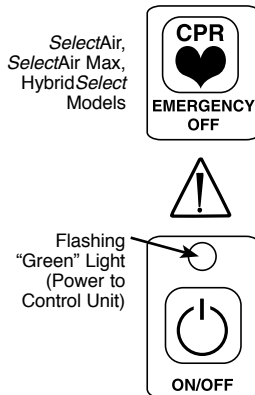

Note: To assist in deflating the mattress, disconnect the hose at the mattress or control unit.

Figure 25

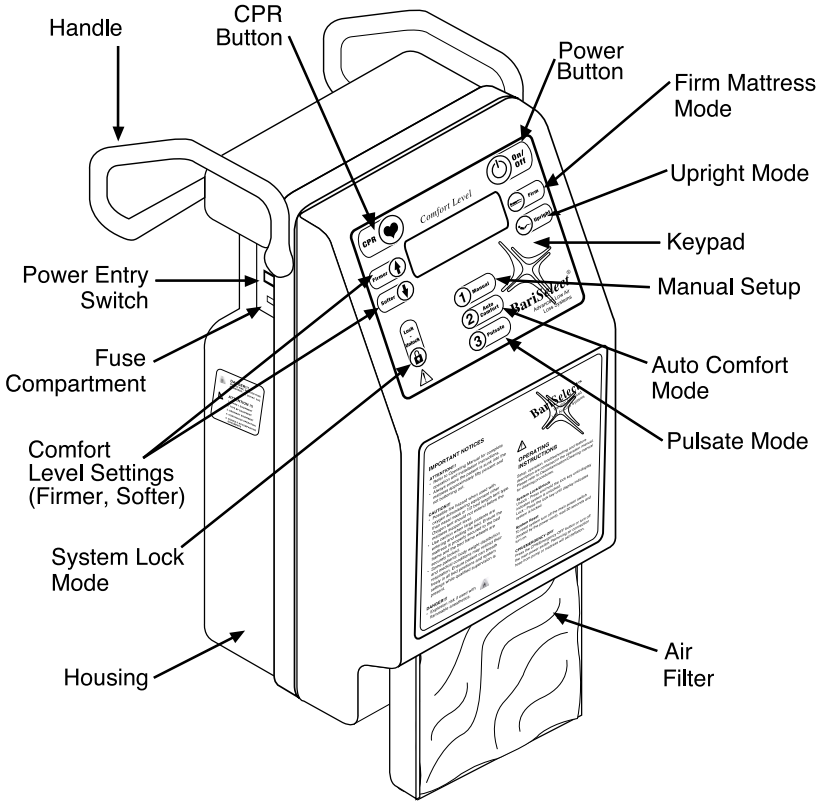

BariSelect

Upright Mode

The Upright Mode increases system pressure to compensate for the upright patient.

Note: When the patient is sitting up in bed, additional system pressure is required to keep the patient properly supported.

1. Before raising the patient to a sitting position, activate the Upright Mode by pressing the "Upright" button once (fig. 26).



Figure 26

2. To deactivate the Upright Mode, first lower the patient to a lying position. Then press the "Upright" button a second time. Ensure the Upright Mode is not indicated on the LCD display.

Note: Do not leave the control unit in the Upright Mode when the patient is lying flat or at a slight angle.

Note: Ensure the patient has at least one (1) inch (3 cm) of clearance between the bed frame and their body. If not, manually increase or decrease system pressure to compensate.

Firm Mattress Mode

To aid in the placement and maneuvering of the patient, the control unit is equipped with a Firm Mattress Mode. The Firm Mattress Mode will fully inflate the mattress making it firm for easy positioning. The Firm Mattress Mode will automatically terminate when the time displayed on the LCD has expired.

1. Press the "Firm" button on the keypad. The display will indicate the remaining time (fig. 27).

Figure 27



2. To end the cycle press the Firm button a second time. Ensure the Firm Mode is not indicated on the LCD display.

Note: The BariSelect control unit is equipped with an internal timer which will turn the Firm Mattress Mode off after 25 minutes. If the Firm Mattress Mode has timed out and ended the firm mattress cycle, DO NOT press the Firm key as this may cause the system to "lock up".

Note: Pressing the Firm key multiple times or holding down the button may cause the system to "lock up".

Note: To ensure patient comfort, the control unit slowly lowers the pressure of the system. This may give the appearance that the firm function is still active. If the Firm mode is not indicated on the LCD display, the control unit is in its normal mode.

System Lock

The BariSelect control unit is equipped with the System Lock which suspends normal keypad operations (with exception of Firm Mattress, Upright and CPR buttons).

- To unlock the control unit, press and hold the "Lock/Unlock" button (Fig. 28) until "Unlock" is displayed in the LCD and a beep is heard (approx. 3 seconds).

- To lock the control panel, press the “Lock/Unlock” button. If no patient activity is detected for 60 seconds, the control unit will automatically lock the system.

Figure 28



Auto Comfort

The BariSelect control unit is equipped with the Auto Comfort mode. When selected, the control unit will proceed through one or several (depending on the patient's body type) cycles and will then calculate the approximate proper setting for the patient. If the setting selected by the control unit is not acceptable, then a second run of the Auto Comfort cycle may be necessary. If manual setup is desired see Manual Setup, Section 6.

Figure 29



- Turn the control unit on and allow the mattress to fully inflate before making any adjustments or placing the patient on the mattress.
- Place the patient on the mattress, centered and in their habitual resting position, i.e. on their back, on their side, etc.
 - Note:** The bed rails should be locked in their highest position before proceeding.
- Deactivate the Firm Mode before starting Auto Comfort.
- Press the Auto Comfort "Start" button (Fig. 29).
 - Note:** The patient must remain still until the cycle is complete.
 - Note:** Do not press any other buttons until the Auto Comfort cycle completes.
- Inspect the patient to ensure they have sunk into the mattress about 40-50% and not touching the frame at any point. If they have not, adjust the Comfort Level using the Comfort Level "Softer" and "Firmer" buttons until the proper results are achieved.
 - Note:** Because weight distribution varies from patient to patient, some patients may require an increase or decrease in the Comfort Level.

Manual Weight Input BariSelect

- When in normal operating mode, press the Manual button on the keypad (fig. 30). The control unit will enter manual weight input mode. The display will change from the system pressure level to user weight in pounds, starting at 400 pounds each time the manual mode is entered.

Figure 30



- Use the Firmer and Softer buttons to adjust the displayed weight to the approximate weight of the user (fig. 31). The Firmer button will increase the display by twenty (20) pounds with each press, the Softer button will decrease the display by (10) pounds with each press.

Figure 31

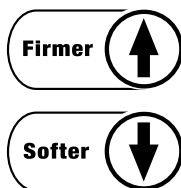

- Once the desired weight is displayed and no buttons are pressed for five (5) seconds, the control unit will revert to normal operation. The display will revert back to the system pressure level and the control unit will then adjust the pressure to the new setpoint. Allow time for the system pressure to stabilize before making further adjustments.

Pulsate Mode

The BariSelect control unit is equipped with the Pulsate Mode. When selected, the control unit will continuously readjust the system pressure (proportional to the Comfort Level setting). The change is gradual to ensure maximum patient comfort.

Figure 32



- Unlock the control unit.
- Press the Pulsate key (Fig. 32).
- Select the Pulsate mode setting by pressing the up and down keys.
- Press the Pulsate key to set the mode into memory. Ensure the proper mode is indicated on the LCD screen.

You may change the rate of pulsation at any time while the Pulsate Mode is in operation.

CPR/Emergency Deflate

Important: In case of a CPR Emergency, turn power OFF by pressing the CPR button on the keypad.

Figure 33



Note: To assist in deflating the mattress, disconnect the hose at the mattress or control unit.

Figure 34

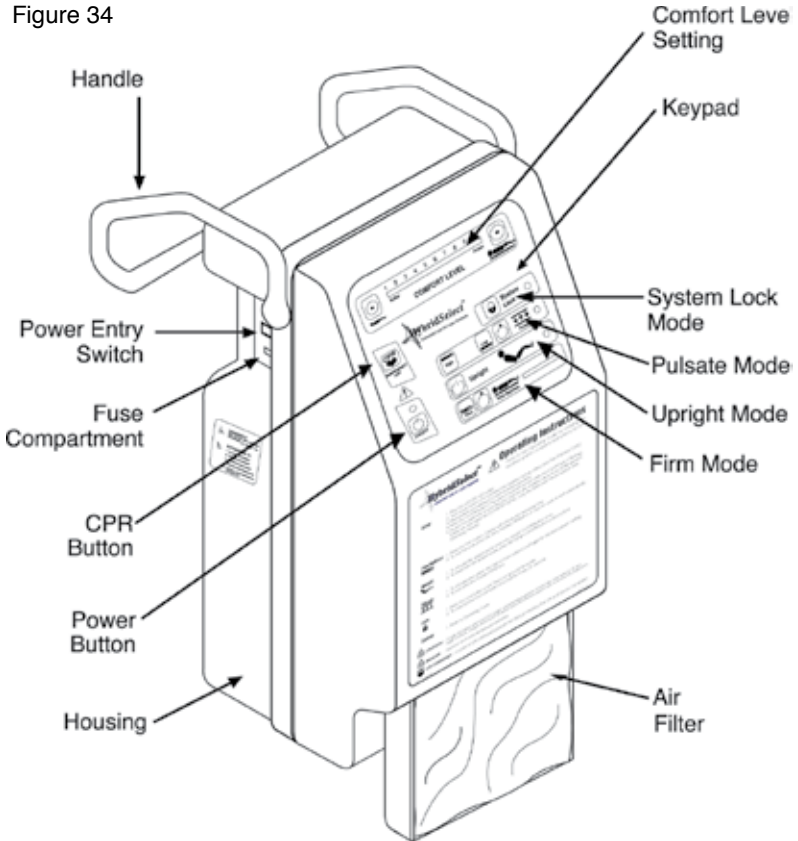

HybridSelect

Upright Mode

The Upright Mode increases system pressure to compensate for the upright patient.

Note: When the patient is sitting up in bed, additional system pressure is required to keep the patient properly supported.

1. Before raising the patient to a sitting position, activate the Upright Mode by pressing the "Upright On/Off" button once (Ensure the Upright light illuminates, (fig. 35).

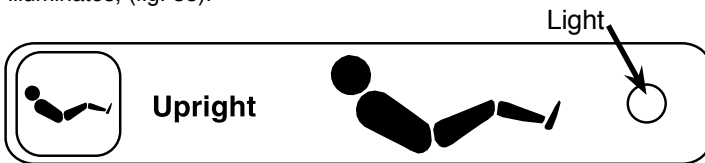

Figure 35

- To deactivate the Upright Mode, first lower the patient to a lying position. Then press the "Upright On/Off" button a second time (Ensure the upright light extinguishes).

Note: Do not leave the control unit in the Upright Mode when the patient is lying flat or at a slight angle.

Note: Ensure the patient has at least one (1) inch (3 cm) of clearance between the bed frame and their body. If not, manually increase or decrease system pressure to compensate.

Firm Mattress Mode

To aid in the placement and maneuvering of the patient, the control unit is equipped with a Firm Mattress Mode. The Firm Mattress Mode will fully inflate the mattress making it firm for easy positioning. The Firm Mattress Mode will automatically terminate when the time displayed on the keypad has expired.

- Press the "Firm" button on the keypad. The display will indicate the remaining time (fig. 36).
- To end the cycle press the Firm Mattress "Off" button.

Figure 36

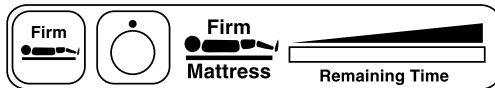

Note: The HybridSelect control unit is equipped with an internal timer which will turn the Firm Mattress Mode off after 25 minutes. If the Firm Mattress Mode has timed out and ended the firm mattress cycle, DO NOT press the Firm "Off" key as this may cause the system to "lock up".

Note: Pressing the Firm "Off" key multiple times or holding down the button may cause the system to "lock up".

Note: To ensure patient comfort, the control unit slowly lowers the pressure of the system. This may give the appearance that the firm function is still active. If the timer lights are extinguished, the control unit is in its normal mode.

System Lock

Control unit is equipped with the System Lock which suspends normal keypad operations (with exception of Firm Mattress, Upright and CPR on/off) until deactivated. When the Firm Mattress button is pressed while the System Lock is activated, the System Lock light will extinguish until the Firm Mattress Mode turns off.

- To lock the control panel, press the "System Lock" button (fig. 37), the System Lock light will come on.

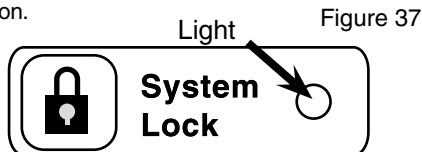

2. To unlock the control panel, press and hold the “System Lock” button for three (3) seconds. Ensure the System Lock light extinguishes.

Pulsate Mode

This control unit is equipped with the Pulsate Mode. When selected, the control unit will continuously readjust the system pressure (proportional to the Comfort Level setting). Change in pressure is gradual to ensure maximum patient comfort.

1. To activate, press either “High” or “Low” key (fig. 38) on the control panel. The Pulsate light will illuminate.

Figure 38

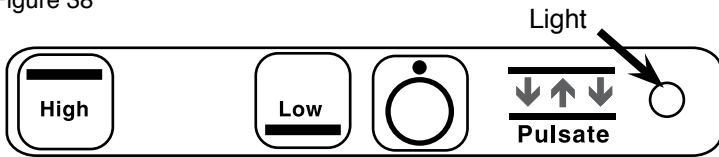

2. The Pulsate Mode adjusts as follows:
 Low—20% cycle every 5 minutes
 High—20% cycle under one minute
3. To deactivate the Pulsate Mode, press the Pulsate **OFF** button (Fig. 39).

Figure 39



Note: You may change the rate of alternating pressure at any time while the Pulsate Mode is in operation.

CPR/Emergency Deflate

Important: In case of a CPR Emergency, turn power OFF by pressing the CPR button on the keypad.

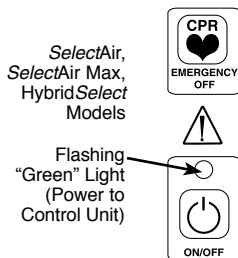

Figure 40

Note: To assist in deflating the mattress, disconnect the hose at the mattress or control unit.

Select Air System Specifications:	<i>SelectAir</i>	<i>SelectAir Max</i>	<i>BariSelect</i> (all sizes)	<i>Hybrid Select</i>
Mattress System Type	Mattress replacement	Mattress replacement	Mattress replacement	Mattress Overlay
Patient Weight Limit	400 lbs.	400 lbs.	680 lbs.	300 lbs.
One Year Limited Warranty	X	X	X	X *
Control Unit Specifications:				
TUV EN 60601-1, IEC60601-1	X	X	X	X
Current - Less than 3 amps	X	X	X	X
Voltage - 120V AC 50/60 Hz	X	X	X	X
Flow Rate 80-100 SLPM	X	X	X	X
Mattress, Cover, Foam, Sheet Specifications				
Flammability - 16 CFR Part 1632 (composite testing)	X	X	X	X
Latex free	X	X	X	X
Surface Resistivity - Anti Static	X	X	X	X
Bacterial Resistance - Meets AATCC-147-1993	X	X	X	X
Control Unit Features:	<i>SelectAir</i>	<i>SelectAir Max</i>	<i>BariSelect</i> (all sizes)	<i>Hybrid Select</i>
Softer/Firmer - Push to increase (firmer) or decrease (softer) comfort level.	X	X	X	X
Upright - Increases pressure to compensate for the upright patient.	X	X	X	X
Firm - Fully inflates mattress to aid in placement and maneuvering of patient.	X	X	X	X
System Lock - Locks the system to deter unauthorized personnel from altering the settings.		X	X	X
Auto Comfort - Automatically adjusts the system according to the patient's weight distribution.		X	X	

Control Unit Features (con't):	SelectAir	SelectAir Max	BariSelect (all sizes)	Hybrid Select
Pulsation - Continually readjusts system pressure. SelectAir Max & BariSelect -Low-every 15 minutes, Medium-every 7 minutes, High-every minute. HybridSelect - Low-every 5 minutes, High-every minute.		x	x	x
CPR/Emergency Deflate - When engaged, allows quick deflation of the system in case of an emergency.	x	x	x	x
Digital Display - (LCD) - Easy to read digital display.			x	
Remote Capability - An optional hand control is available (additional cost) which allows the patient to self-adjust the softer/firmer and power features.			x	
Back-lit Keys - Allow system features to be visible in dim/dark environments.			x	

* Refer to DRY FLOATATION cushioning product Operations Manual for cushion information.

SelectAir 5 Year Product Warranty

MOXI Enterprises, LLC warrants the *SelectAir* (Model SASTDPUMP), *SelectAirMax* (Model SAMAXPUMP), *HybridSelect* (Model SAHYBPUMP) and *BariSelect* (Model SABARIPUMP) control units for a period of sixty (60) months from date of purchase.

The mattress component is warranted for a limited sixty (60) month period. Wear and tear, as a result of normal product usage, is not covered under warranty. Mattresses subjected to harsh cleaning chemicals, such as bleach, are not covered under warranty. The five year control unit and mattress warranty does not apply to any product purchased prior to January 1, 2011.

The mattress cover, and all other mattress system components will be warranted for a period of twelve (12) months.

MOXI Enterprises, LLC will repair or replace (at its option) any components that, upon examination by a MOXI/*SelectAir* representative or agent, are found to be defective within the limits of the warranty.

To obtain service under the terms of this warranty, the user must notify MOXI Enterprises, LLC, its representatives or agent of the defect noted within the time limit of this warranty. Proof of purchase must be included with the return to be considered as warranty product. No product will be accepted for return without prior authorization. Any repair made to the control unit or component by anyone other than a MOXI/*SelectAir* Technician VOIDS the warranty in its entirety. Tampering with a warranted component VOIDS the warranty in its entirety. Components to be returned must be cleaned (disinfected) prior to return, and must be securely packaged.

This warranty does not apply to any products that have been subjected to damage in accident, misuse or abuse.

The user assumes all risk and liability in connection with determining the suitability of the system and its components for a particular use. MOXI Enterprises, LLC and its representatives and agents shall not be liable for injury, loss or damage arising out of the improper use or operation of the system. There are no warranties, implied beyond those stated for any consequential damages or loss resulting from failure of this product to perform in the manner anticipated.

For additional information, please contact MOXI at (800) 942-7678, (314) 771-5222 or by fax at (314) 771-5225.

Some states do not allow the exclusion or limitations of incidental or consequential damages, so the above limitations or exclusions may not apply to you.

*These terms and conditions may not apply to all Moxi manufactured product.



1939 South Vandeventer Avenue, Saint Louis, Missouri 63110
www.moxiusa.com

Toll Free: 1.800.942.7678 • Local: 314.771.5222 • Fax: 314.771.5225